

4x

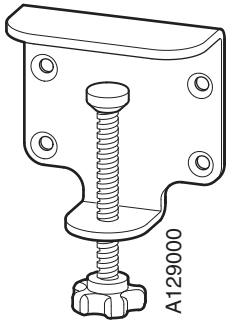

2x



1x

1

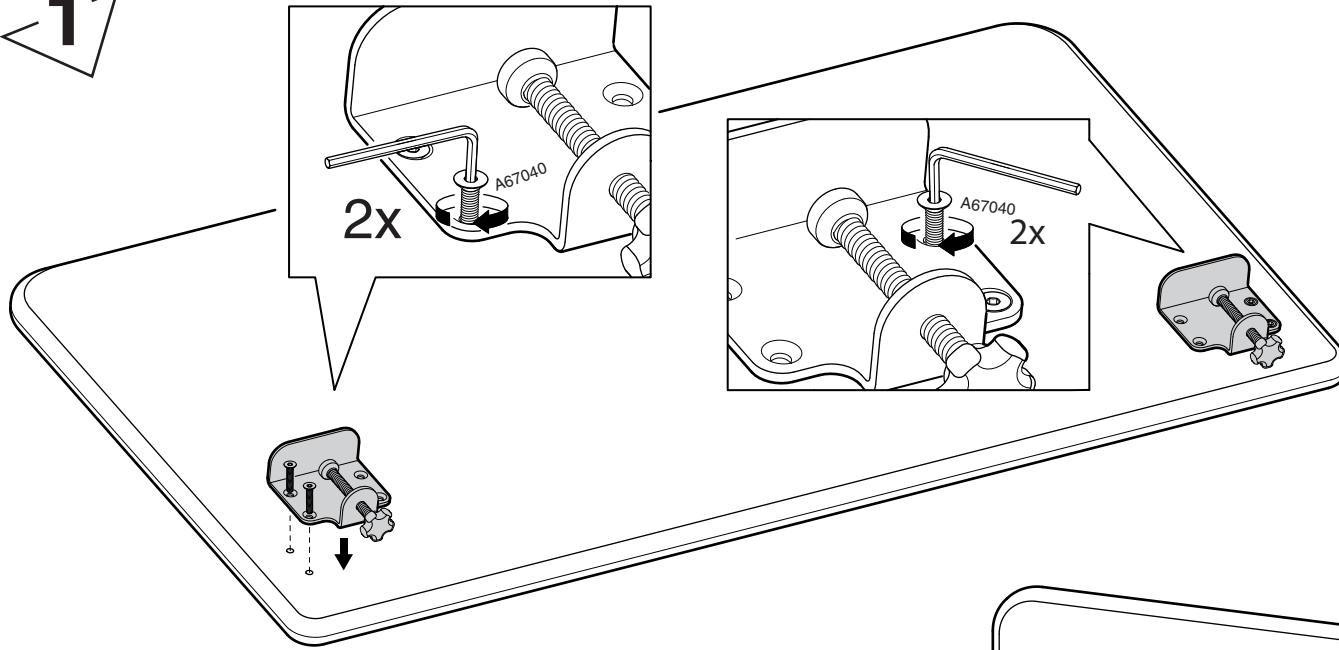

2

