

A67099

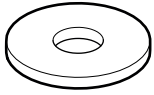

A67117



A67128

4x

4x

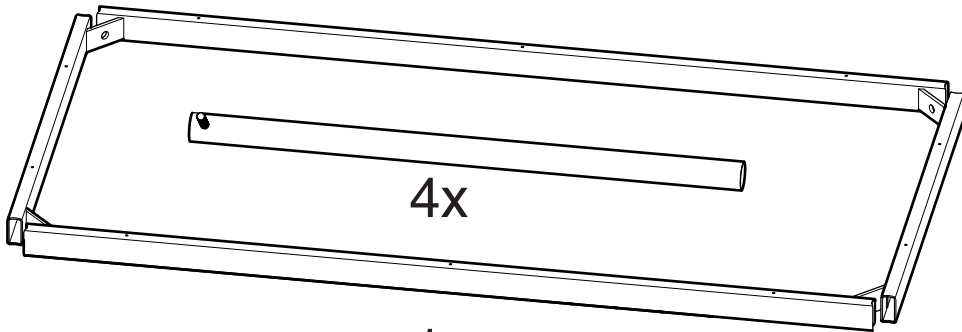

4x

1x

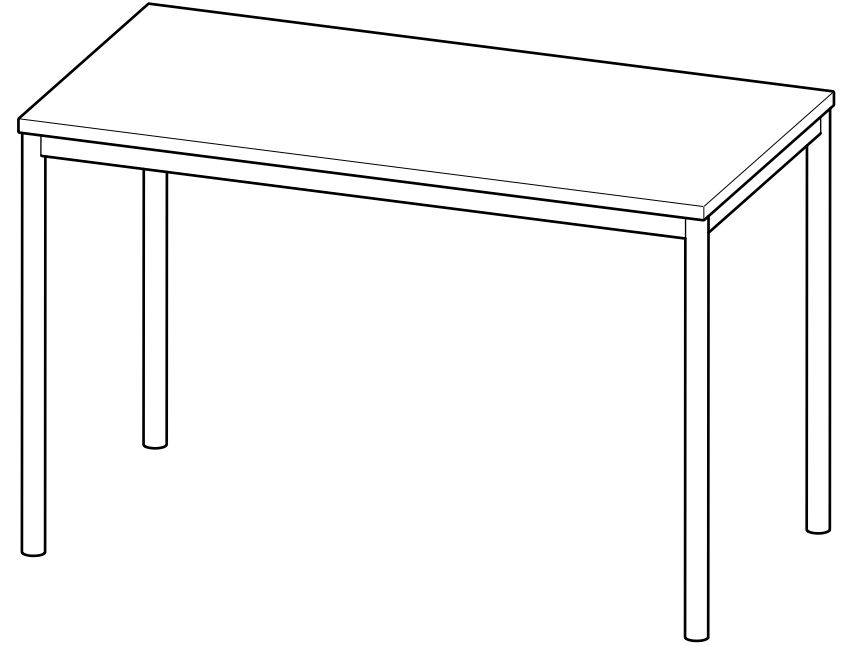

1

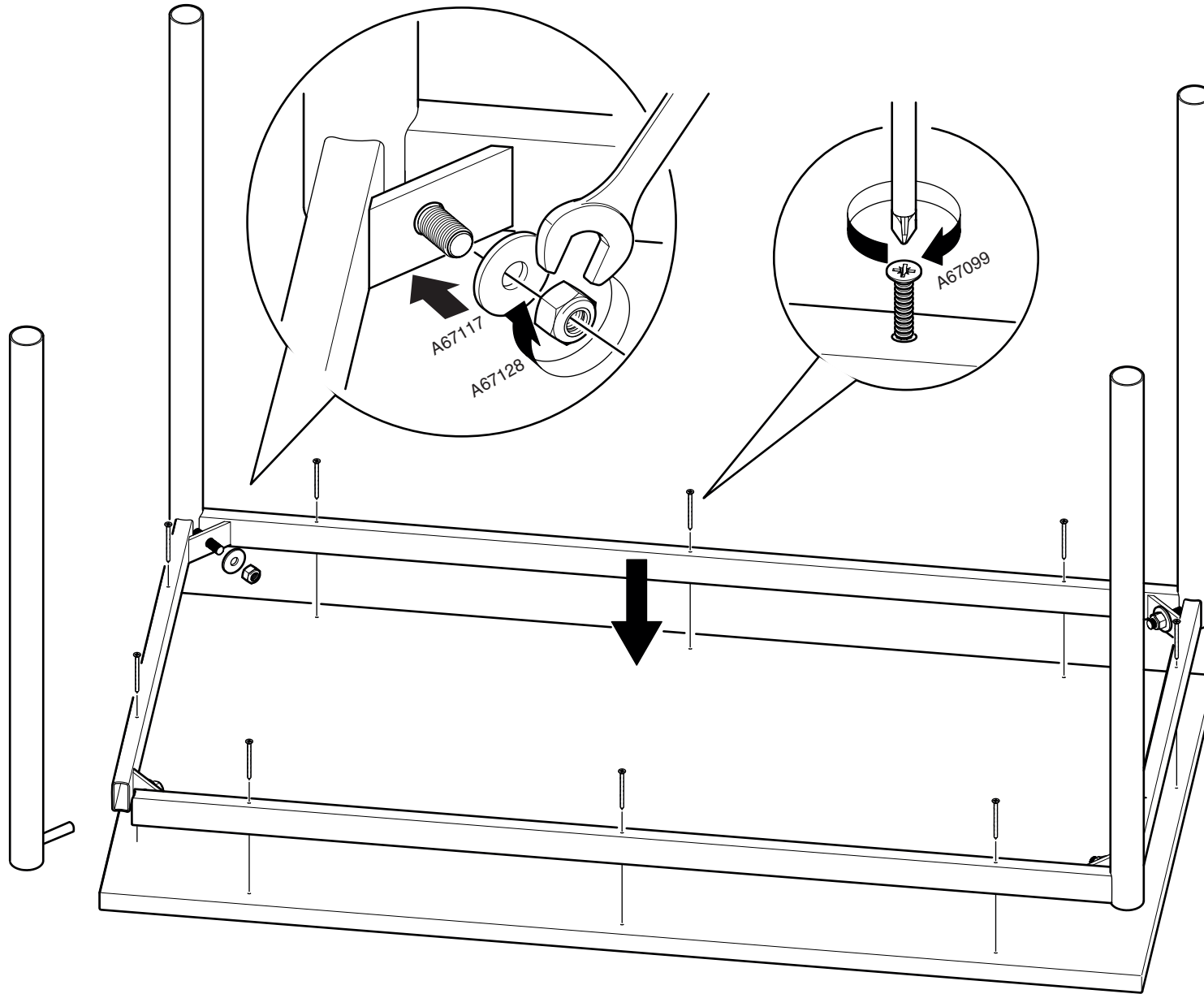

REPAIR & DISASSEMBLY

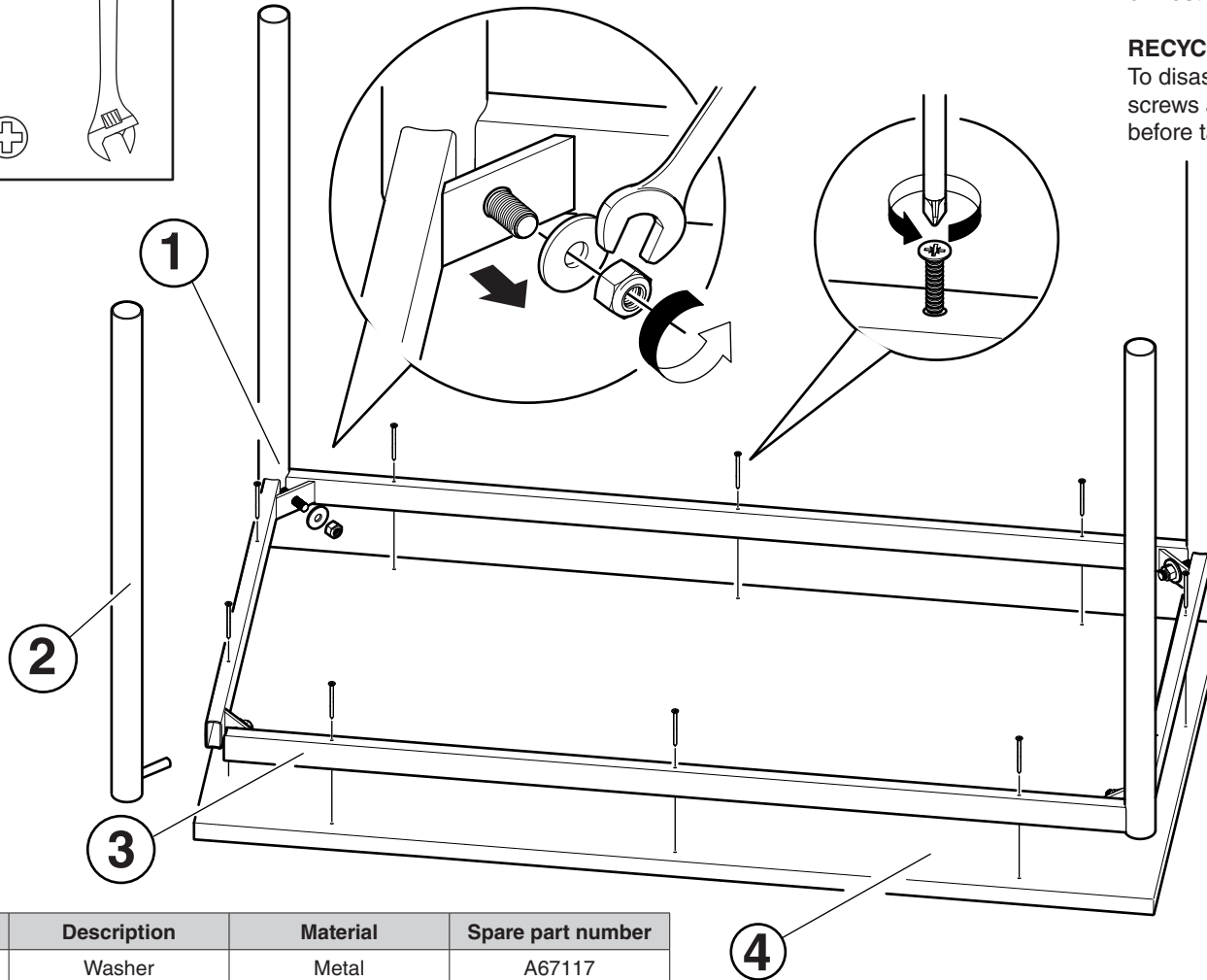
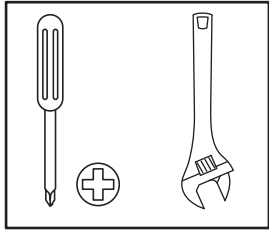

REPAIR

Carefully remove the broken part and secure the new one in its place using appropriate tools and hardware shown in either in the assembly instructions or illustration below. All parts are interchangeable.

RECYCLING

To disassemble the furniture for proper recycling, start by removing all screws and fasteners, then separate materials like wood, metal, and fabric before taking them to the respective recycling facilities.

Part	Description	Material	Spare part number
1	Washer	Metal	A67117
1	Locking nut	Metal	A67128
1	Wooden screw	Metal	A67098
2	Leg	Metal	-
3	Frame	Metal	-
4	Table top	Wood	-



Contact your local Aj seller for spare parts.

REPARATION & ÅTERVINNING

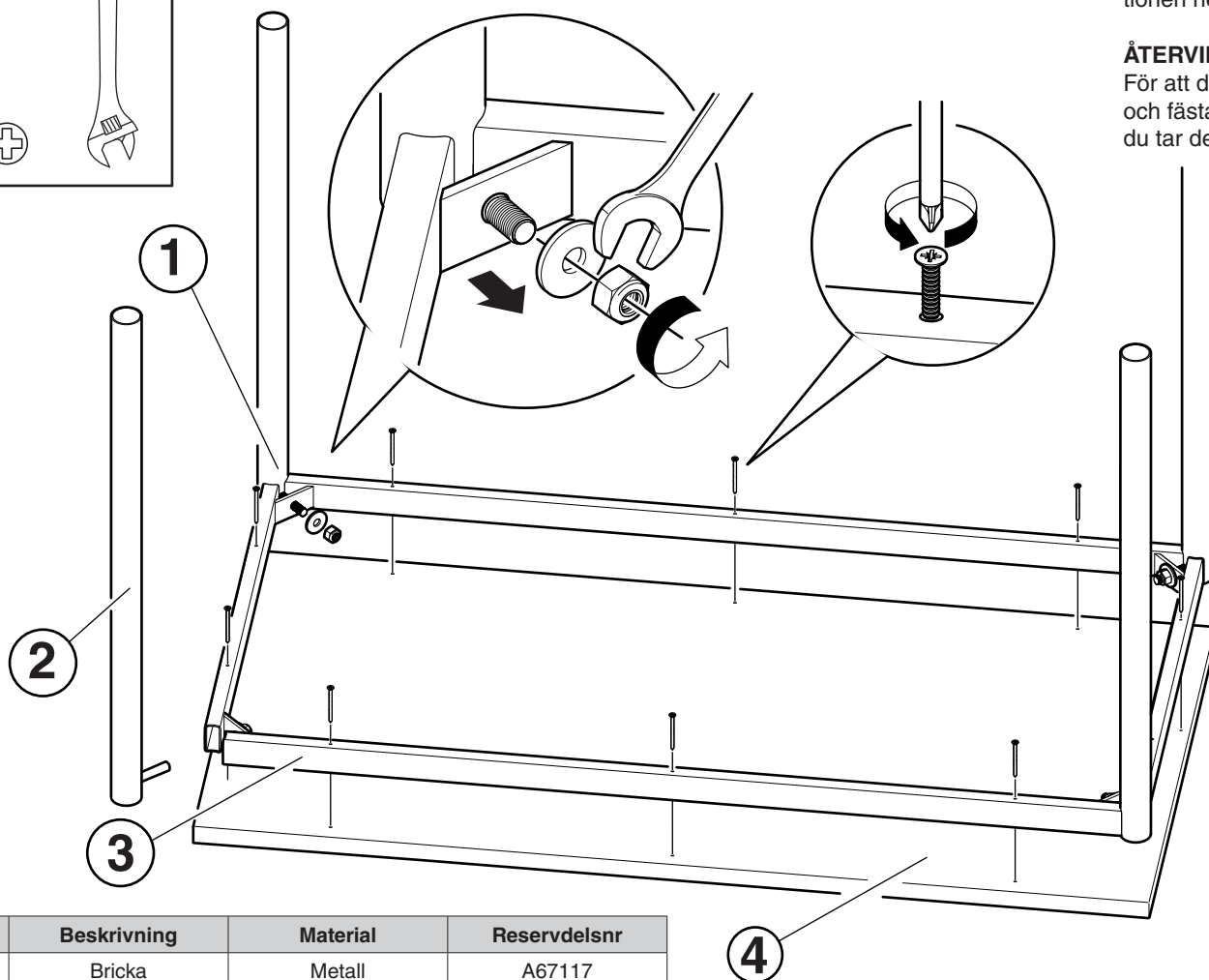
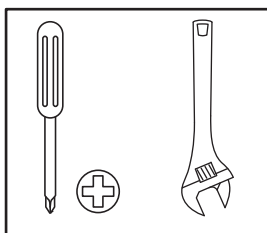

Del	Beskrivning	Material	Reservdelsnr
1	Bricka	Metall	A67117
1	Låsmutter	Metall	A67128
1	Träskruv	Metall	A67098
2	Ben	Metall	-
3	Ram	Metall	-
4	Bordsskiva	Trä	-

REPARATION

Ta bort den trasiga delen och montera den nya på plats med lämpliga verktyg och beslag som visas antingen i monteringsanvisningarna eller illustrationen nedan. Samtliga delar går att byta ut.

ÅTERVINNING

För att demontera möbelen för återvinning, börja med att ta bort alla skruvar och fästordningar, sedan separera material som trä, metall och tyg innan du tar dem till respektive återvinningsanläggningar.



Kontakta Aj Produkter för reservdelar.