

LI-101 User Manual



Table of Contents

Safety Precaution.....	2
Chapter 1 Keyboard Instruction.....	3
Chapter 2 Specifications	4
Chapter 3 Front and Rear Panels	5
3-1 Front Panel	5
3-2 Rear Panel.....	6
Chapter 4 Installation	7
4-1 Load Cell.....	7
4-2 Dimension.....	8
4-3 Battery Assemble.....	9
Chapter 5 External Function Parameter Setting.....	10
5-1 External Function Setting.....	11
5-2 RS232 Setting.....	13
Chapter 6 Internal Setting Mode	18
6-1 Specification Setting	19
6-2 Internal Weight Calibration.....	22
6-3 Internal Function Setting	24
6-4 Error Messages	26
Chapter 7 Special Function	27
7-1 Animal Scale Setting.....	27
7-2 Dual Range Resolution Switch Function.....	28
7-3 Pre-tare Function	29
7-4 Resolution Switch Function.....	29
7-5 Peak Hold Function.	30
Chapter 8 Interface	31
8-1 OP-01 RS232/RS485 Serial Output (with RTC)	31
Chapter 9 Maintenance	33
9-1 Default Recovery for All Parameters.....	33
9-2 Default Recovery for General Function Parameters	33
9-3 Self-diagnosis Mode.....	33
9-3-1 Program Version Number	34
9-3-2 7-segment Display Testing	34
9-3-3 Keypad & Calibration Switch Testing.....	34
9-3-4 AD Conversion Value.....	34
9-3-5 EEPROM Testing	34
9-3-6 RTC Time & Date Testing	34
9-3-7 RS-232 Serial Output Interface Testing (OP-01).....	34
Appendix 7-SEGMENT DISPLAY CHARACTERS.....	35

Before using the product





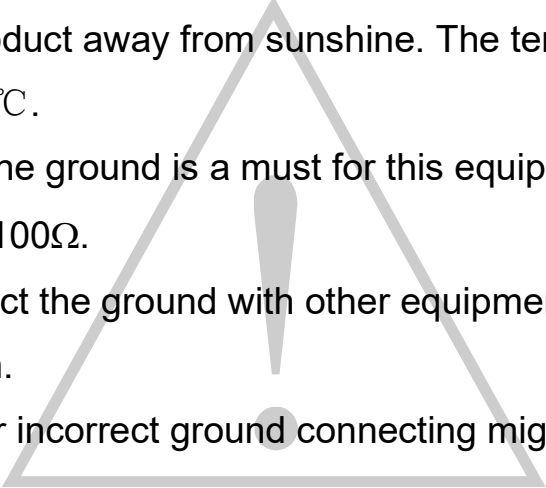

Thank you for purchasing LI-101 indicator.

In order to operate smoothly, to last the durability, and to reduce the chance of breakdown for this product, please read the following User Manual carefully.

Safety Precaution

- & Turn off power before installing or disassembling.
 - & Keep the product away from sunshine. The temperature range for operation is 0°C ~ +40°C.
 - & To connect the ground is a must for this equipment. The ground impedance is less than 100Ω.
 - & Never connect the ground with other equipments which are huge in power consumption.
 - & No ground or incorrect ground connecting might cause the electric shocks or breakdowns.
- 

Chapter 1 Keyboard Instruction

Function	Operation	Description
General Function Setting	Press and hold  , and then press 	Refer to <Chapter 5> External Function Parameter Setting for details
Weighing Parameter Setting	Adjust calibration switch to ON	Setting for decimal point, capacity, division, zero tracking, and unstable detecting, etc. Refer to 6-1 Specification Setting for details.
Calibration	Adjust calibration switch to ON	Refer to 6-2 Internal Weight Calibration for operation.
Self-diagnosis Mode	While turning on with countdown, press and hold 	Refer to 9-3 Self-diagnosis Mode for details.
Default Recover for All Parameters	Adjust calibration switch to ON, and then press and hold  	Refer to 9-1 for details.
Default Recovery for General Function Parameters	While turning on with countdown, press and hold  	Refer to 9-2 for details.

 During the operation, use the following keys to complete all the works.



} To add the value flashing

F2



} To move the cursor rightward

TAR

} To reduce the value flashing



} Storage setting



} To move the cursor leftward

(|)



} To abort setting/to exit

Chapter 2 Specifications

Analog Specification

- ◆ Load Cell Current: DC 5V –5% 60mA (Up to Four 350Ω Load Cells)
- ◆ Max. Load Cell Input Voltage: 16 mV
- ◆ Input Sensitivity: 0.15μV/D or more
- ◆ Conversion Rate: Approximately 120 times/sec. (max.)
- ◆ Resolution: 20 bits

Digital Specification

- ◆ Display: LCD, 6 digits, height 25.4x10mm, LEDbacklight (Black digits for FM; red digits for FMR)
- ◆ Display Frequency: 50 times/sec.(max.)
- ◆ Display Range: - 999999 ~ 999999
- ◆ Min. Division: 1, 2, 5, 10, 20, 50
- ◆ Decimal Point: 0, 0.0, 0.00, 0.000, 0.0000
- ◆ Memory: Calibration parameter and function setting are all stored in EEPROM.

Optional Interface

- ◆ OP-01 RS-232 / RS-485 (Includes RTC Function)

Power Requirement

- ◆ Adaptor Spec.: Input 120/230VAC 50~60Hz, output 9V/1000mA
- ◆ Optioanl 2 types of batteries: 6V Hi-MH rechargeable battery kit (5pcs)
or
General batteries (5pcs)
- ◆ Max. Power Consumption:
110mA (with 4 Load Cells + backlight + RS-232 interface)
NiMH battery → 15 hours
General battery → 24 hours
45mA (with 1 Load Cell + no backlight + no RS-232 interface)
NiMH battery → 36 hours
General battery → 60 hours

Others



- ◆ Operation Temperature: 0°C ~ 40°C
- ◆ Operation Humidity: < 85% R.H.
- ◆ Dimension: W 49.5 • L193 • H134 (mm)
- ◆ Weight: 700g

Chapter 3 Front and Rear Panels

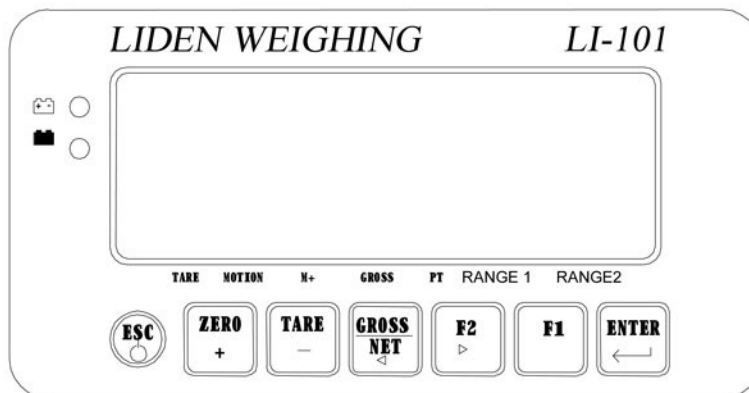





3-1 Front Panel



Indication:

-  : Battery charged status (only available to charged model)
-  : Battery charging status (only available to charged model)
- TARE : Tare status
- MOTION : Unstable weighing indication
- M+ : Accumulation status indication
- GROSS : Gross weight
- PT : Pre-tare
- RANGE1 : Dual-range resolution induction (1)
- RANGE2 : Dual-range resolution induction (2)

Keypad:

-  1) Power ON / OFF. Press and hold this key for 3 seconds to shut down.
2) To abort or exit when setting.
-  1) Weight re-zero.
2) To add the value when setting.
-  1) To eliminate the gross weight.
2) To reduce the value when setting.
-  1) To switch Gross / Net weight shown on display.
2) To move the cursor leftward when setting.
-  1) Keypad function (FNC-02 & FNC-03).
2) To move the cursor rightward when setting.
-  Keypad function (FNC-02 & FNC-03).
-  Confirmation key.

3-2 Rear Panel

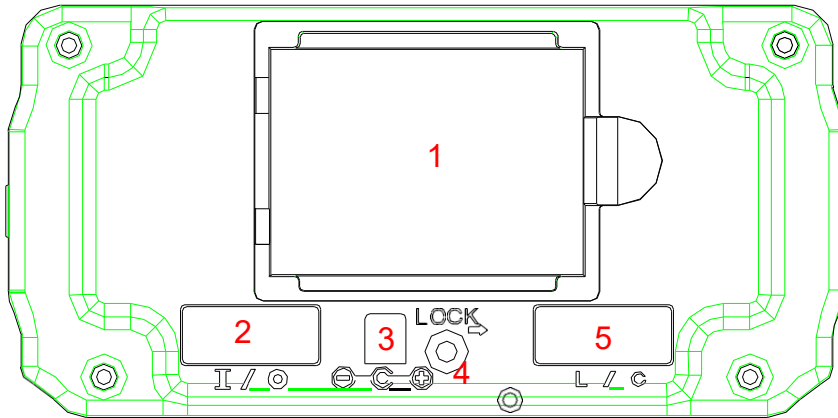

1. Battery Case
2. RS232/485 Input/Output
3. DC 9V Power Input
4. Calibration Switch
5. Load Cell Connect Socket

Chapter 4 Installation

4-1 Load Cell

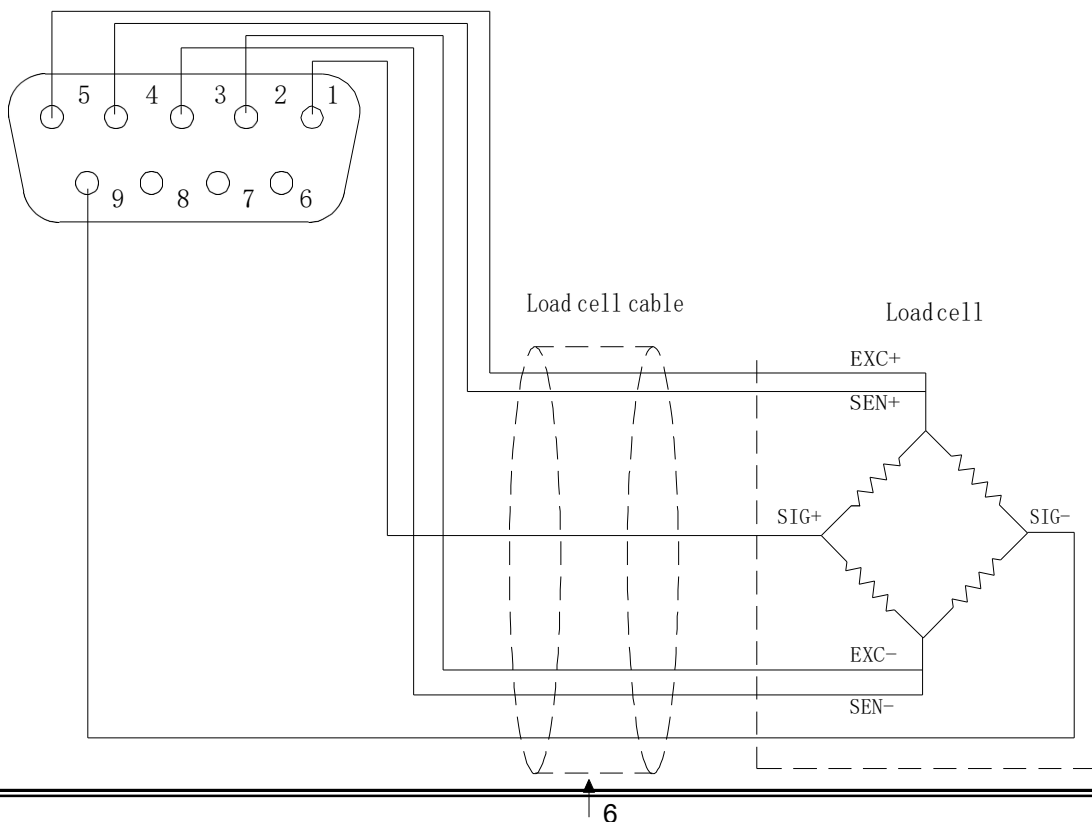

Shield

4-wired (5-wired) Load Cell

Pin 4, 5 short to connect with EXC+
Pin 2, 3 short to connect with EXC-
Pin 1 connects with SIG+
Pin 9 connects with SIG-
Pin 6, 7, 8 connects with Shield

6-wired (7-wired) Load Cell

Pin5 connects with EXC+
Pin4 connects with SEN+
Pin3 connects with EXC-
Pin2 connects with SEN-
Pin1 connects with SIG+
Pin9 connects with SIG-
Pin6, 7, 8 connect with Shield

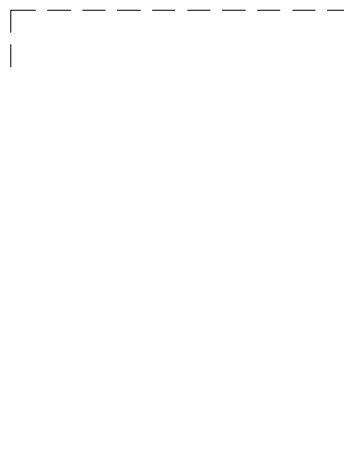

4-2 Dimension

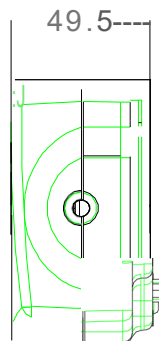
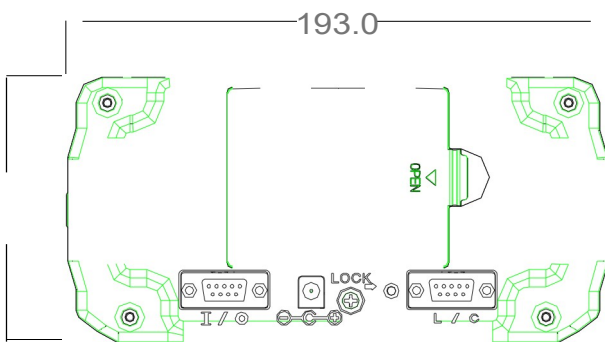
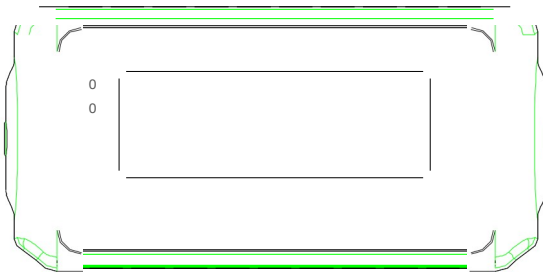
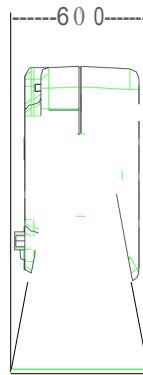
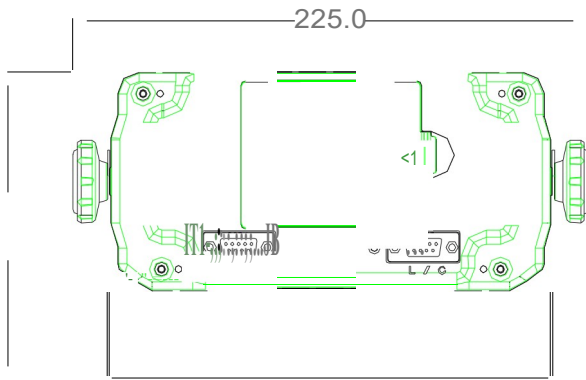
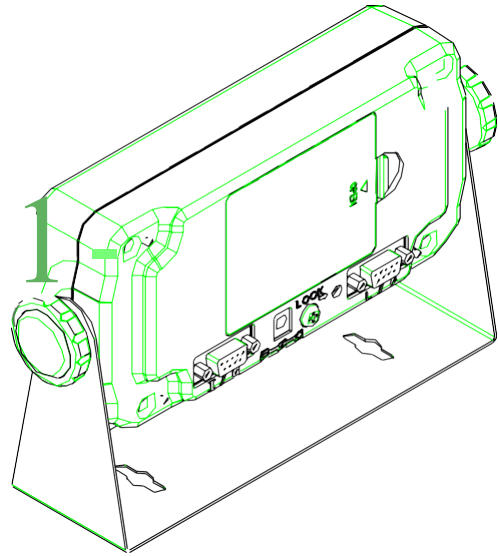
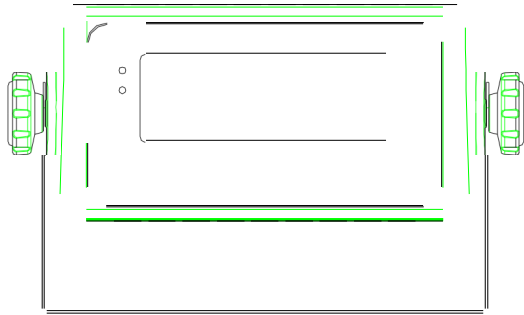

4-3 Battery Assemble

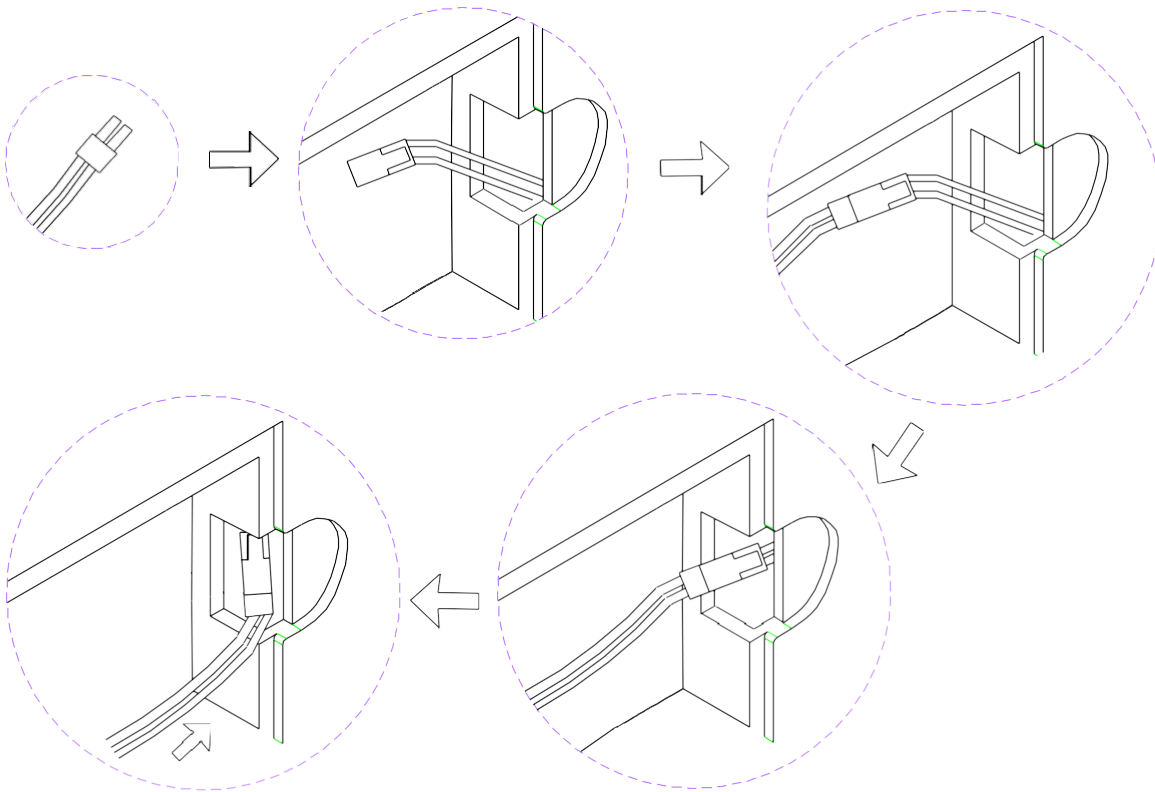

Stuff the surplus wires into the battery case.

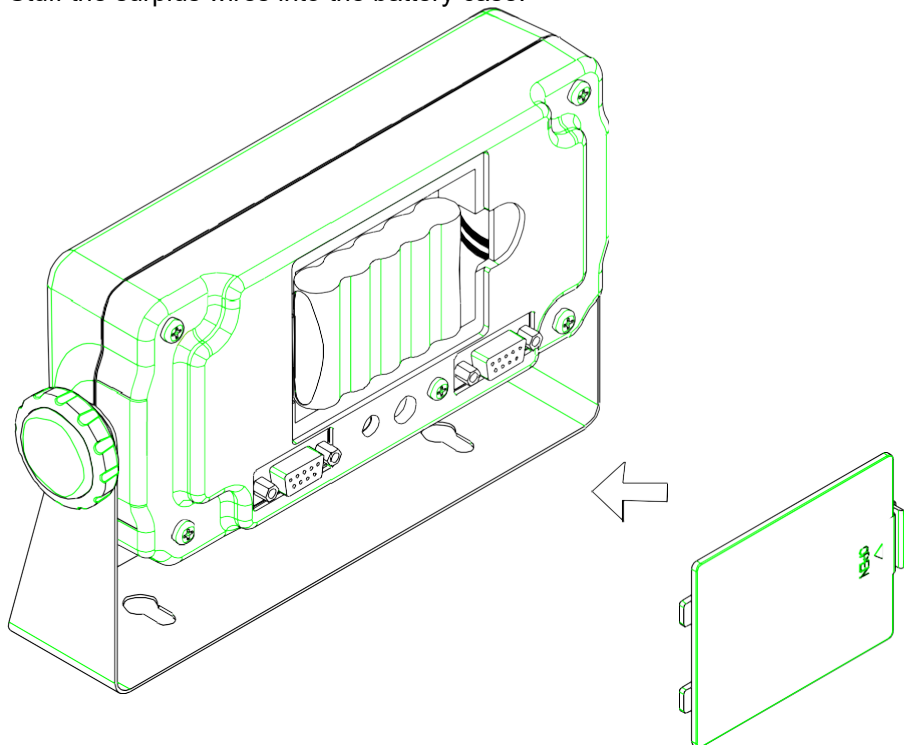

Chapter 5 External Function Parameter Setting

Under general weight display status, press **F1** **ENTER**, and the screen will display:

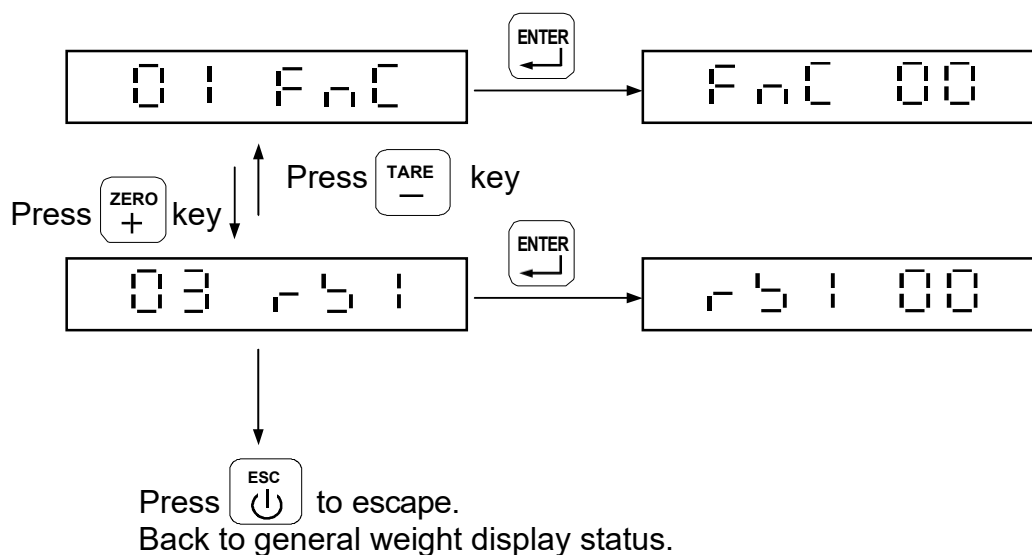

01 Fnc } External function setting

03 r51 } RS232/RS485 interface function

5-1 External Function Setting

0 1 F n C

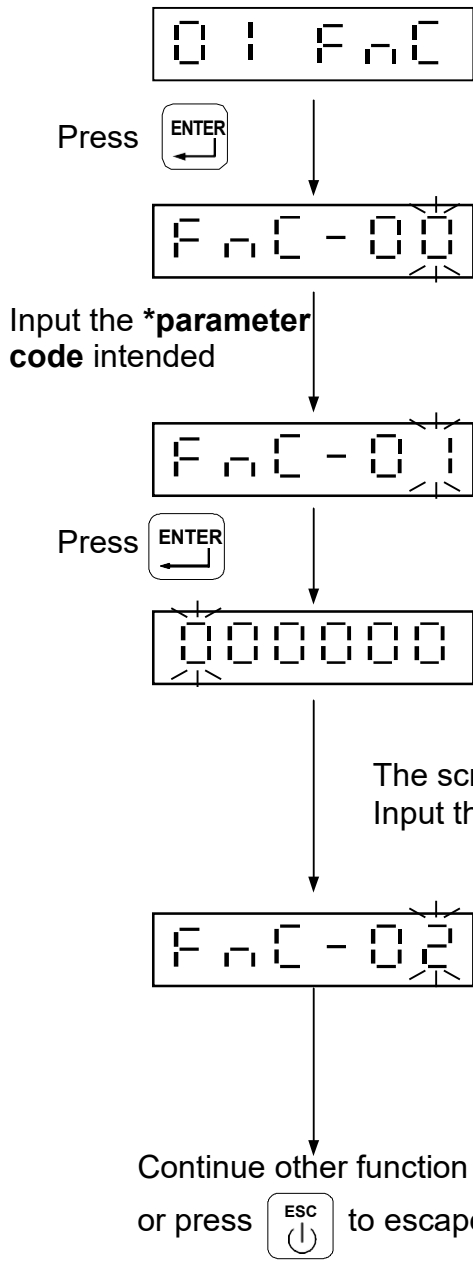

*Parameter Code

- } Key Disable
- } DSP Update (Display Update)
- } F1 Key Function Setting
- } F2 Key Function Setting
- } ENTER+F2 Function Setting
- } Backlight Function Setting
- } Beeper Setting

The screen displays the parameters set previously. Input the parameters intended and then press

- } To add the value flashing
- } To reduce the value flashing
- } To move the cursor leftward
- } To move the cursor rightward
- } Save setting
- } To abort setting or exit

External Function Parameter Setting

Parameter Code	Function	Setting Value			Default Setting	
		Parameter	Description			
FNC-00	Key disable	0000	0	ON	0000 is corresponding to:(from left to right) 	0000
		<input type="checkbox"/> 1111	1	OFF		
FNC-01	DSP Update	0	No Limit		1	
		1	20 times/sec.			
		2	10 times/sec.			
		3	5 times/sec.			
		4	1 times/sec.			
FNC-02	F1 Key Function Setting	0	Print (printing)		5	
		1	Units (units switch)			
		2	M+ (accumulation and printing)			
		3	MC (memory clearing)			
		4	Weight/Weight Accumulation/Times Accumulation Display Switch			
		5	HR (high resolution switch)			
		6	Pre-tare (pre-tare function)			
FNC-03	F2 Key Function Setting	0	Print (printing)		1	
		1	Units (units switch)			
		2	M+ (accumulation and printing)			
		3	MC (memory clearing)			
		4	Weight/Weight Accumulation/Times Accumulation Display Switch			
		5	HR (high resolution switch)			
		6	Pre-tare (pre-tare function)			
FNC-04	ENTER+F2 Function Setting	0	Print Function (Print)		0	
		1	Units Shift (Units)			
		2	Accumulation and Print (M+)			
		3	Clean the Accumulation Value (MC)			
		4	Weight/AccumulationValue/ AccumulationTimes Shift Display			
		5	Resolution Conversion (HR)			
FNC-05	Backlight Setting	0	Auto Backlight On (backlight on in operation only)		1	
		1	Backlight On (backlight always on)			
		2	Backlight Off			
FNC-06	Beeper Setting	0	Beeper off		1	
		1	Beeper on			

5-2 RS232 Setting 03 r 5 1

03 r 5 1

Press 

r 5 1 - 00

Input the *Parameter code intended

r 5 1 - 01

Press 

0000000

The screen displays the parameters set previously. Input the parameters intended and then press



r 5 1 - 02

Continue other functions setting

or press  to escape.

*Parameter Code

- r 5 1 - 00 } Information Pattern
- r 5 1 - 01 } Transmission Method
- r 5 1 - 02 } Transmission Rate
- r 5 1 - 03 } Parity, Bit Length, Stop Bit
- r 5 1 - 04 } Unstable or Over Load
- r 5 1 - 05 } Auto Transmission Condition
- r 5 1 - 06 } Command Address
- r 5 1 - 07 } Output Format
- r 5 1 - 08 } Transmission Times
- r 5 1 - 09 } Date Setting
- r 5 1 - 10 } Time Setting

 } To add the value flashing

 } To reduce the value flashing

 } To move the cursor leftward

 } To move the cursor rightward

 } Save setting

 } To abort setting or exit

OP-01 RS232 RS485 Interface Function

Parameter Code	Function	Setting Value		Default Setting
		Parameter	Description	
RS1-00	Information Pattern (Please refer to page 16)	0	Display Correspondingly	0
		1	Gross Weight	
		2	Net Weight	
		3	Tare	
		4	Weight Accumulation Value	
		5	Times Accumulation Value	
		6	Output with Date & Time	
RS1-01	Transmission Method	0	Continuous Transmission	0
		1	Auto Transmission	
		2	Press <input type="button" value="F1"/> or <input type="button" value="F2"/> to transmit	
		3	Command Mode (no address)	
		4	Command Mode (with address)	
RS1-02	Transmission Rate	0	1200	1
		1	2400	
		2	4800	
		3	9600	
		4	19200	
RS1-03	Parity Bit Length Stop Bit	0	N, 8, 1 No Parity 8 Bits Length 1 Stop Bit	2
		1	O, 7, 1 Odd Parity, 7 Bits Length, 1 Stop Bit	
		2	E, 7, 1 Even Parity, 7 Bits Length, 1 Stop Bit	
RS1-04	Unstable or Over Load	0	Continuous Output	0
		1	Stop Output	
RS1-05	Auto Transmission Condition	0	Positive (over + 10D)	0
		1	Positive/negative (over + 10D, under - 10D)	
RS1-06	Command Address	00 □ 99	Available only if RS1-01 setting is "4"	0
RS1-07	Output Format	0	Standard Format	0
		1	UMC 600	

RS1-08	Transmission Times	0	No Limit	4
		1	1 times/sec.	
		2	2 times/sec	
		3	5 times/sec	
		4	10 times/sec	
		5	20 times/sec	
RS1-09	Date Setting			
RS1-10	Time Setting			

☐ Transmission Format

RS1-00 } 0 ~ 3

S	T	,	G	S	,	+	1	2	3	4	.	5	6		g	CR	LF
---	---	---	---	---	---	---	---	---	---	---	---	---	---	--	---	----	----

Header 1 Header 2 Weight Data (8 digits) Unit Terminators

Header 1

ST: Stable Weight / US: Unstable Weight / OL: Weight Overload

Header 2

GS: Gross Weight / NT: Net Weight / TR: Tare

Weight Data (8 digits)

The first digit of weight data represents “+/-“indication for weight value. The other 7 digits, including decimal point, represent the weight value. If the weight is over load (Header 1: OL), the screen turns into “blank” except “+/-“indication and decimal point.

Unit

Kg, lb, t or “blank”

Terminators

CL and LF are data termination code.

RS1-00 = 4

T	N	,	1	2	3	CR	LF
---	---	---	---	---	---	----	----

RS1-00 = 5

T	W	,	+	1	2	3	4	.	5	6	k	g	CR	LF
---	---	---	---	---	---	---	---	---	---	---	---	---	----	----

RS1-00 = 6

D	A	T	E		:	2	0	X	X	/	X	X	/	X	X	CR	LF
T	I	M	E		:	X	X	:	X	X	:	X	X	CR	LF		
G	R	O	S	S	:	+	1	2	3	4	.	5	6	k	g	CR	LF
N	E	T			:	+	1	2	3	4	.	5	6	k	g	CR	LF
T	A	R	E		:	+	1	2	3	4	.	5	6	k	g	CR	LF
T	N				:	X	X	X	CR	LF							
T	W				:	+	1	2	3	4	.	5	6	k	g	CR	LF

☞ Command Mode

Command	Function	Command	Function
READ/RW	Weight Reading	CT	Tare Clearing
ZERO/MZ	Weight Re-zeroing	RI	Weight Accumulation
TARE/MT	Gross Weight Deducting	Rm	Times Accumulation
NTGS	Gross / Net Switch	Rn	Date
MG	Gross Weight Indicating	Ro	Time
MN	Net Weight Indicating	AT	Weight and Times Accumulation
		DT	Weight and Times Accumulation Clearing

- ☒ After setting the commands mentioned above, it's necessary to add the termination code "CR (0DH) and LF (0AH)".
 - ☒ If the command is not correct, it will reply "E" + "Command Unidentified".
 - ☒ If setting command mode with address (RS1-06 = 4), add "@ address" in front of each command.
- Example:** When RS1-06 = 1, for reading weight value, the whole complete command should be "@01RW (CR) (LF)".

Chapter 6 Internal Setting Mode

Adjust calibration switch to "ON", and the screen displays:

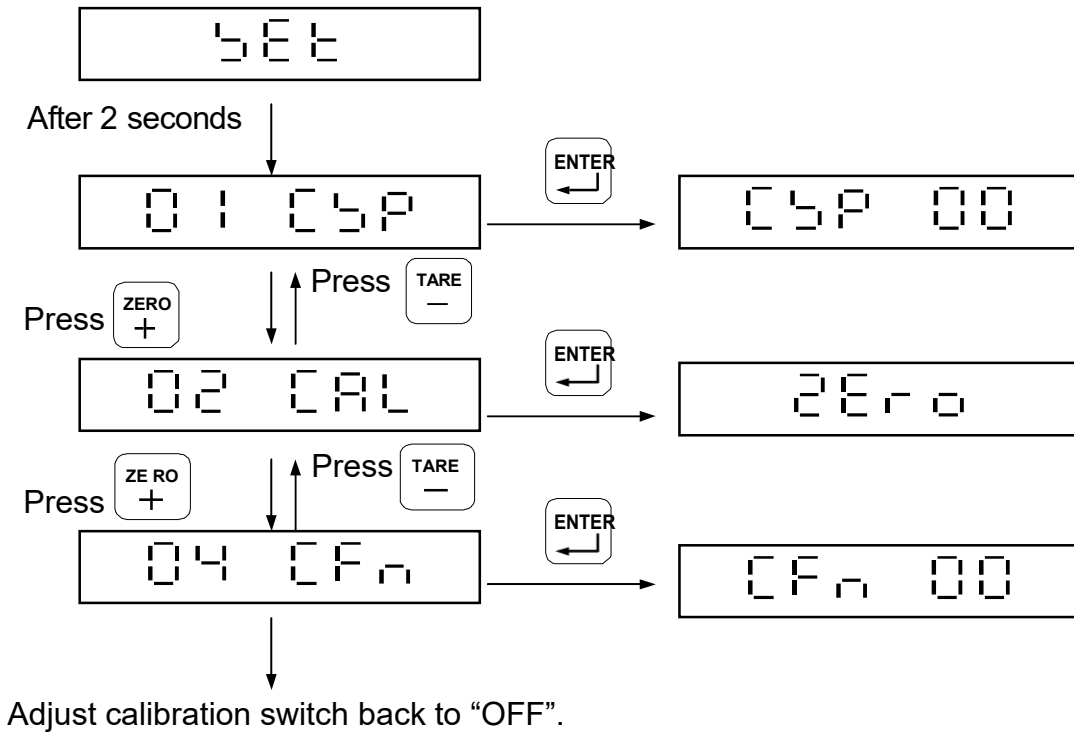

- 01 C5P } Specification Setting
- 02 CAL } Internal Weight Calibration
- 04 CFn } Internal Function Setting

6-1 Specification Setting

01 C5P

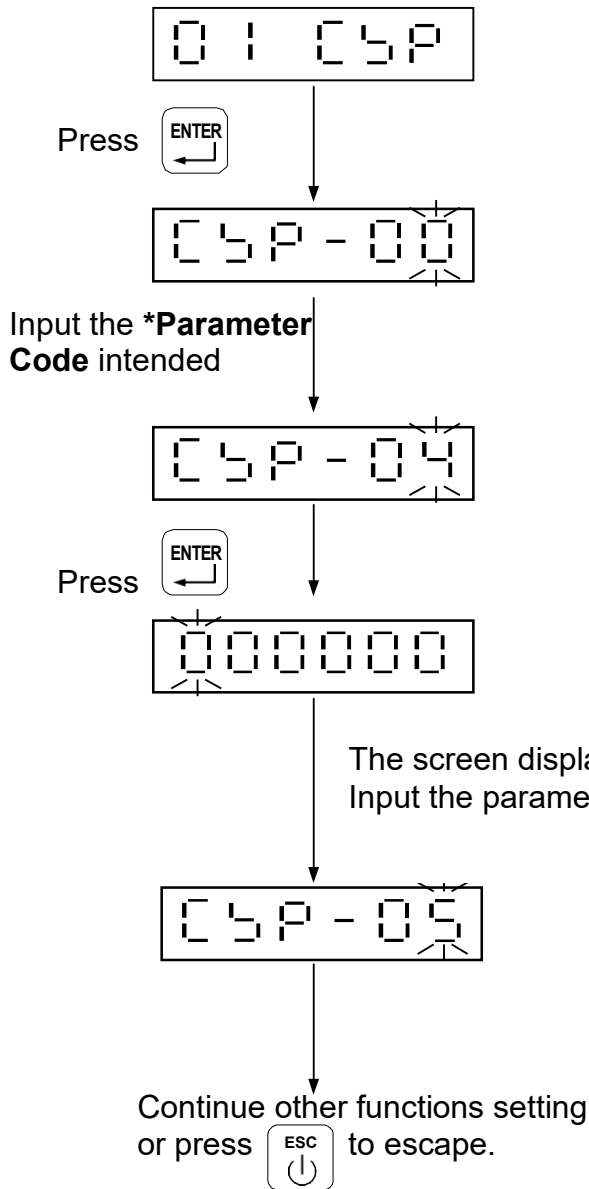

*Parameter Code

- F5P - AA } Decimal Point
- C5P - 01 } Maximum Weighing Capacity
- C5P - 02 } Division 1
- C5P - 03 } Division 2
- C5P - 04 } Zero Tracking Setting
- C5P - 05 } Unstable Detecting Setting

	} To add the value flashing
	} To reduce the value flashing
	} To move the cursor leftward
	} To move the cursor rightward
	} Save setting
	} To abort setting or exit

☐ Specification Parameter Description

Parameter Code	Function	Setting Value		Default Setting
		Parameter	Description	
CSP-00	Decimal Point		Refer to the description on next page.	0
CSP-01	Maximum Weighing Capacity	999999 ☐ 000000	Max. value for weight display	999999
CSP-02	Division 1	1	Min. value for weight display	1
		2		
		5		
		10		
		20		
		50		
CSP-03	Division 2	1	Min. value for Weight display	1
		2		
		5		
		10		
		20		
		50		
CSP-04	Zero Tracking Setting		Refer to the description on next page.	0.25 D / 1 sec
CSP-05	Unstable Detecting Setting		Refer to the description on next page.	0.25 D / 1 sec

Parameter Display Description

CSP-00 Decimal Point

Display	Decimal Point Digit
d 0	None
A 00	1 Digit
A 000	2 Digits
A 0000	3 Digits
A 00000	4 Digits

CSP-04 Zero Tracking Setting

Display	Division/Time
0.25 d	0.25 D / 1 sec
.75 d	0.5 D / 1 sec
0.75 d	0.75 D / 1 sec
1 d	1D / 1 sec
1.25 d	1.25 D / 2 sec
1.5 d	1.5 D / 2 sec
1.75 d	1.75 D / 2 sec
2 d	2 D / 2 sec
00	No Zero Tracking

CSP-05 Unstable Detecting Setting

Display	Division / Time
0.25 d	0.25 D / 1 sec
.75 d	0.5 D / 1 sec
0.75 d	0.75 D / 1 sec
1 d	1D / 1 sec
1.25 d	1.25 D / 2 sec
1.5 d	1.5 D / 2 sec
1.75 d	1.75 D / 2 sec
2 d	2 D / 2 sec
00	No Unstable Detecting

6-2 Internal Weight Calibration 02 CAL

Turn on and warm up the machine for 15 to 30 minutes before calibration.

Adjust calibration switch to “ON”, and the screen will display **02 CAL**

Press **TARE** or **ZERO** to select **02 CAL**.

Procedure

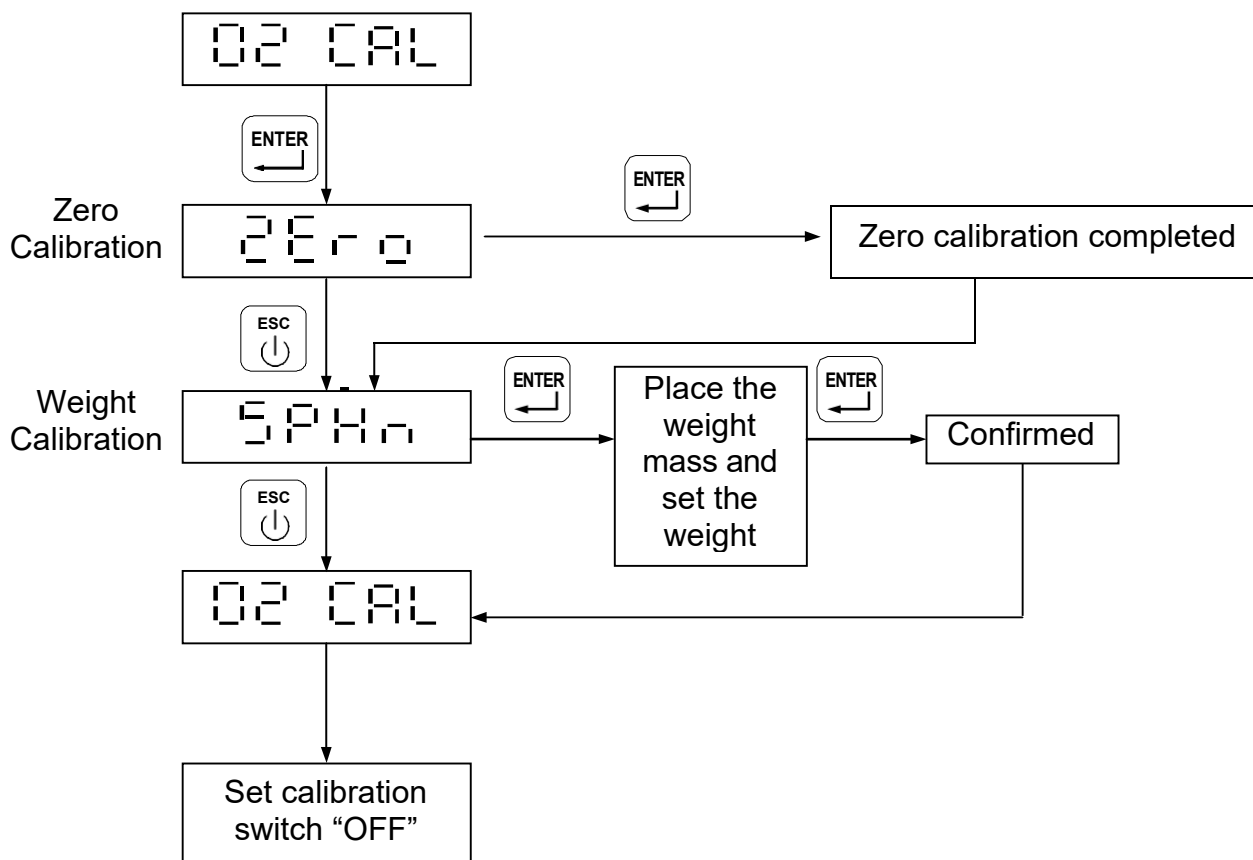

Zero Calibration

- Ensure nothing on the platter; after being stable, press **ENTER**, and the screen will display “.....”. The zero calibration will be complete 5 seconds later.
- To abort zero calibration, just press **ESC**.

Weight Calibration

- Place an object, whose weight is known, on the platter, and input the weight value from front panel. After being stable, press **ENTER** and the screen will display “.....”. The weight calibration will be complete 5 seconds later.
- To abort weight calibration, just press **ESC**.

Password Setting

Adjust calibration switch to "ON"

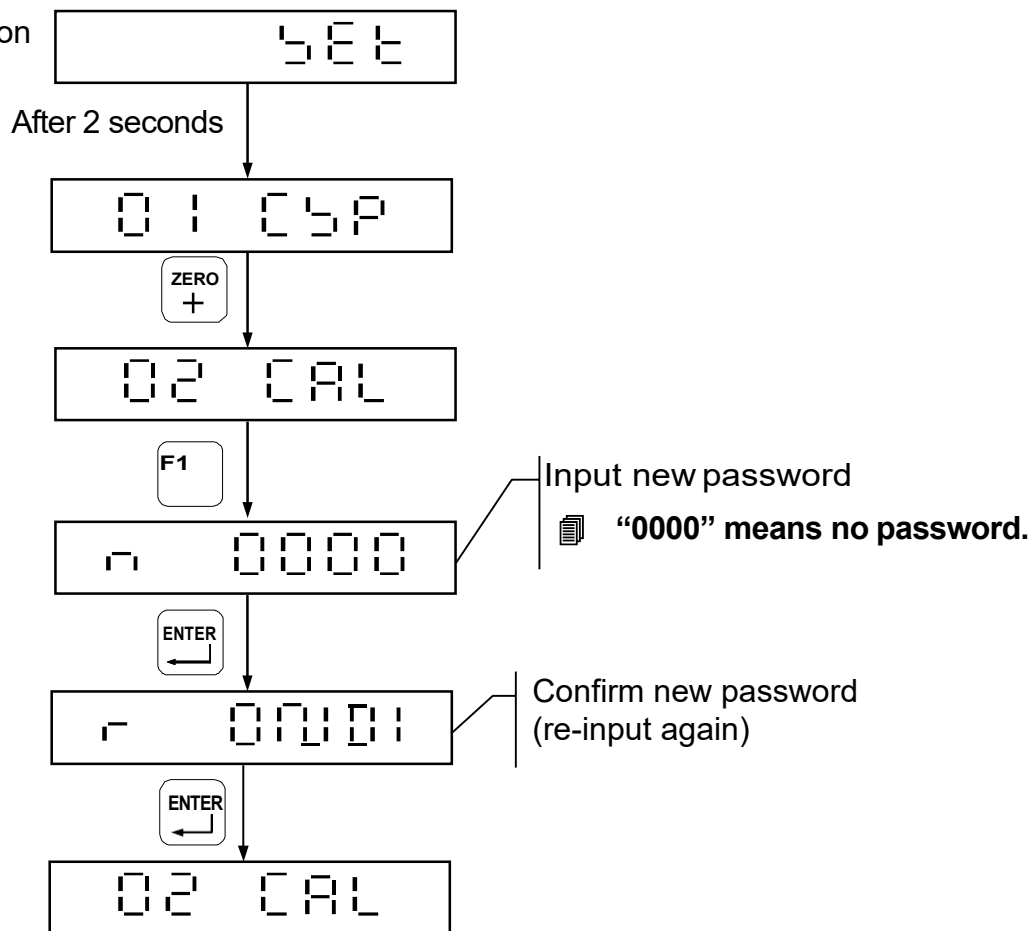

After complete password setting, when entering calibration mode or function setting mode, the screen displays `F 1` for 1 second, and then `. 0 0 0 0 0 0`. It's necessary to input the correct password to continue each setting.

If the password inputted is not correct, the screen displays `F 1`.

6-3 Internal Function Setting

04 CFn

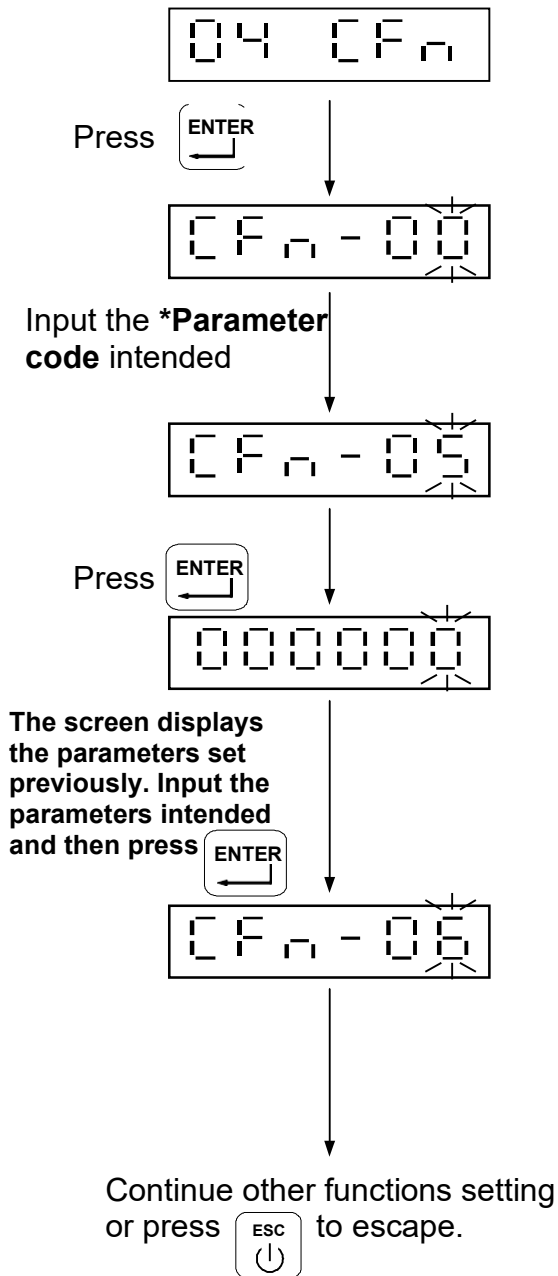

*Parameter Code

- CFn-00 } Tare or Zero Function under Unstable Status
- CFn-01 } Last Zero-recal function
- CFn-02 } Re-zero Range
- CFn-03 } Filter Strength
- CFn-04 } Animal Scale Sampling Rate
- CFn-05 } Animal Scale Mode
- CFn-06 } Animal Scale Stable Range
- CFn-07 } Animal Scale Sampling Rate
- CFn-08 } Dual Range Resolution Setting
- CFn-09 } AD Sampling Frequency
- CFn-10 } The Segment Point Setting of the Two Segment Resolution
- CFn-11 } G Value Calibration

☞ Internal Function Parameter Description

Parameter Code	Function	Setting Value		Default Setting
		Parameter	Description	
CFN-00	Tare or Zero Function under Unstable Status	0	ON	1
		1	OFF	
CFN-01	Last Zero-recal function	0	ON	1
		1	OFF	
CFN-02	Re-zero Range	0% ~ 30%	0%: Full range re-zero 1% ~ 30%: Capacity • – setting value%	2
CFN-03	Filter Strength	0 ~ 5	Strength increases by number	2
CFN-04	Animal scale Sampling Rate	0	No limit	0
		1	20 times/sec.	
		2	10 times/sec.	
		3	5 times/sec.	
CFN-05	Animal Scale Mode	0	OFF	0
		1	Mode 1: No weight display under unstable status	
		2	Mode 2: Weight display whether under stable or unstable status	
CFN-06	Animal Scale Stable Range	0 ~ 100	Mode 2: Stable Range Setting	30
CFN-07	Animal Scale Sampling Frequency	0	8 times	2
		1	16 times	
		2	32 times	
		3	64 times	
		4	128 times	
CFN-08	Dual Range Resolution Setting	0	Multi - interval	0
		1	Multi - range	
CFN-09	AD sampling Rate	0 ~9	Strength increases by number	4
CFN-10	Dual Range Resolution Middle Point Setting	0 ~999999	Set point of dual-range resolution	5000
CFN-11	G value calibration	9.78032 9.83218	Produce place G value setting or operation place different G value adgusting	9.79585

6-4 Error Messages

- (1) \overline{E} \overline{r} \overline{r} $\overline{0}$ Load Cell or A/D circuit extraordinary
- (2) \overline{E} \overline{r} \overline{r} $\overline{0}$ Real weighing value \cong zero value
- (3) \overline{E} \overline{r} \overline{r} \overline{E} Internal resolution $<$ $0.15\mu\text{V}/\text{D}$ range
- (4) \overline{E} \overline{r} \overline{r} . Incorrect password
- (5) \overline{E} $\overline{0}$ Turning on zero $<$ zero range
- (6) \overline{E} $\overline{0}$ Turning on zero $>$ zero range

Chapter 7 Special Function

7-1 Animal Scale Setting

☐ CFN-05 = 1

(Animal Scale Mode1: No weight display under unstable status)

When there is nothing on the platter, the screen will display:

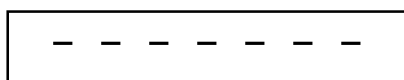

When the object is on the platter, after weight has been measured, the screen will display:

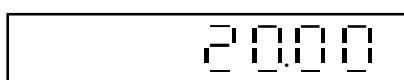

If the display weight value keeps being lower than zero plus 10d or press Enter key to start weighing, then the screen will display:

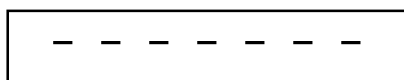

☐ CFN-05 = 2

(Animal Scale Mode 2: Weight display weather under unstable or stable status)

When the weight value reaches the range of CFN-06 and CFN-07 setting, the screen will keep displaying the weight value.

When the weight value is over the range of CFN-06 and CFN-07 setting, the screen will display the normal weight measurement.

For example: CFN-06=30d CFN-07=2

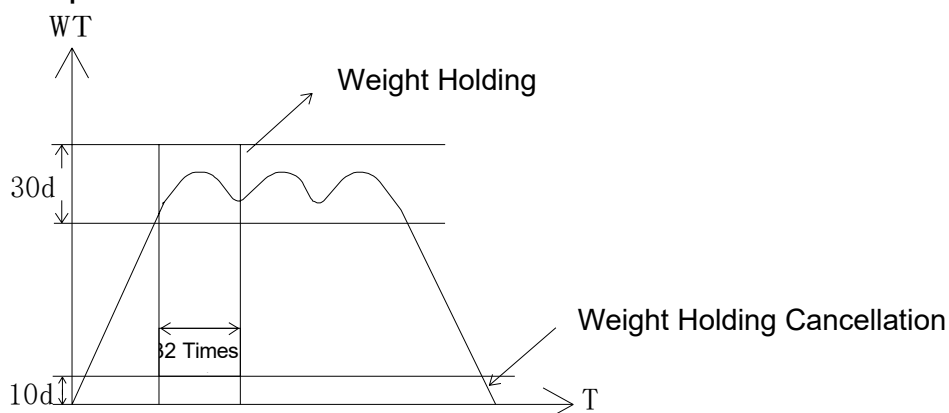

7-2 Dual Range Resolution Switch Function

If the setting of CSP-02 is not the same as CSP-03, the dual range resolution will be activated.

CFN-08 = 0 Multi - interval

If CFN-09 = 5000

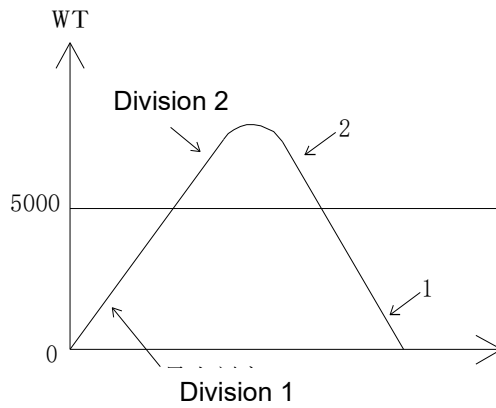

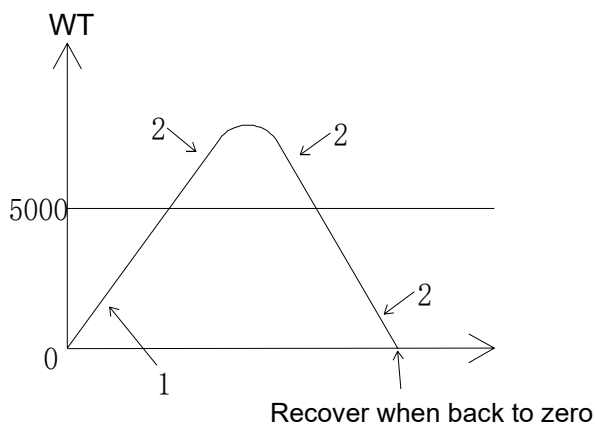

CFN-08 = 1 Multi - range

If CFN-09 = 5000



7-3 Pre-tare Function

☐ FNC-02 or FNC-03 setting is at parameter 6. (Pre-tare Function)

Under weight display status, press  or  key (according to FNC setting), the screen will display:

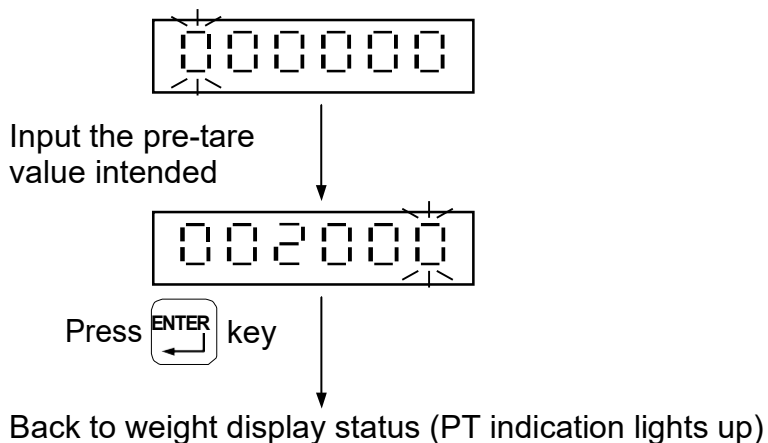



Pre-tare Cancellation

When the gross weight is displayed as "0", press  key to cancel the pre-tare value.

7-4 Resolution Switch Function

☐ FNC-02 or FNC-03 setting is at parameter 5. (HR)

Under weight display status, press  or  key (according to FNC setting), the screen will display 10 times resolution, and then, recovery back to original after 5 seconds.

7-5 Peak Hold Function

Key	Description	Key	Description
<ZERO/+>	Increase the flash value by one	<GROSS/NET>	Move the cursor leftward
<TARE/->	Decrease the flash value by one	<F2>	Move the cursor rightward
<ENTER>	Confirm / Enter key	<ESC>	Abort setting or exit

Detailed procedures

1. Power on the scale.
Press <F1> and <ENTER> keys to enter into the advanced functions mode.
And the screen will show [01 Fnc].
2. Press the <ENTER> key and the screen will show [Fnc-00].
3. Use <ZERO/+> and <TARE/-> keys to set it to be [Fnc-07] and then press the <ENTER> key.
And the screen will show the last setting [hold ?], where ? maybe 0, 1 or 2.

By factory default, it is set to be [hold 0].

4. Use <ZERO/+> and <TARE/-> keys to make it to be your preferred setting and then press the <ENTER> key to confirm your selection.

When set to [hold 0], the PEAK HOLD function is NOT enable and hence keeps in the original weighing function.

When set to [hold 1], the indicator is in "PEAK HOLD 1" mode.

The transmission mode of its RS-232 will also enter into this PEAK HOLD mode accordingly. When the weigh of the target object is over 10d, the indicator will HOLD the highest weighed value for any coming weighing operations, until the pressing of <ENTER> key.

Once the <ENTER> key is pressed, this PEAK HOLD weighed value will be sent out via the RS-232 transmission.

For example,

1st weighing 10 kg, the indicator will show 10 kg;

2nd weighing 5 kg, the indicator will show 10 kg;

3rd weighing 15 kg, the indicator will show 15 kg;

When pressing the <ENTER> key, the indicator will send out the value of 15 kg via RS-232 transmission immediately. And then, the indicator is ready for showing the next PEAK HOLD value.

When set to [hold 2], the indicator is in "PEAK HOLD 2" mode.

The transmission mode of its RS-232 will also enter into this PEAK HOLD mode accordingly. When the weigh of the target object is over 10d, the indicator will HOLD the highest weighed value for any coming weighing operations.

When the weigh of the target object starts to become below 10d, the indicator will then show that value and send out the last PEAK HOLD weighed value via the RS-232 transmission.

For example,

1st weighing 10 kg, the indicator will show 10 kg;

2nd weighing 5 kg, the indicator will show 10 kg;

3rd weighing 15 kg, the indicator will show 15 kg;

4th weighing 8 kg, the indicator will show 15 kg;

5th weighing 100 g (taking 100 g to be 10d), the indicator will show 15 kg;

6th weighing 90 g (i.e. below 10d), the indicator will send out the value of 15 kg via RS-232 transmission immediately. And then, the indicator is ready for showing the next PEAK HOLD value.

5. Press <ESC> key to quit the PEAK HOLD function setting.

Chapter 8 Interface

8-1 OP-01 RS232/RS485 Serial Output with RTC (Real Time Clock)

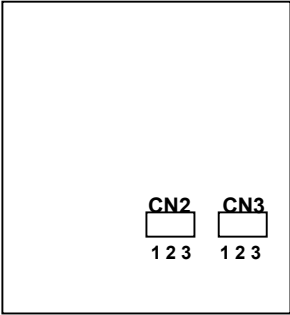

To short 1 and 2 pins is RS485 output.
To short 2 and 3 pins is RS232 output.

Pin Allocation of Rear Panel

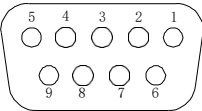

Pin	Function
2	RXD
3	TXD
5	SG
6	DA
7	DB

RS485 interface is capable to connect up to 10 indicators.

☞ Connection Description (RS485)

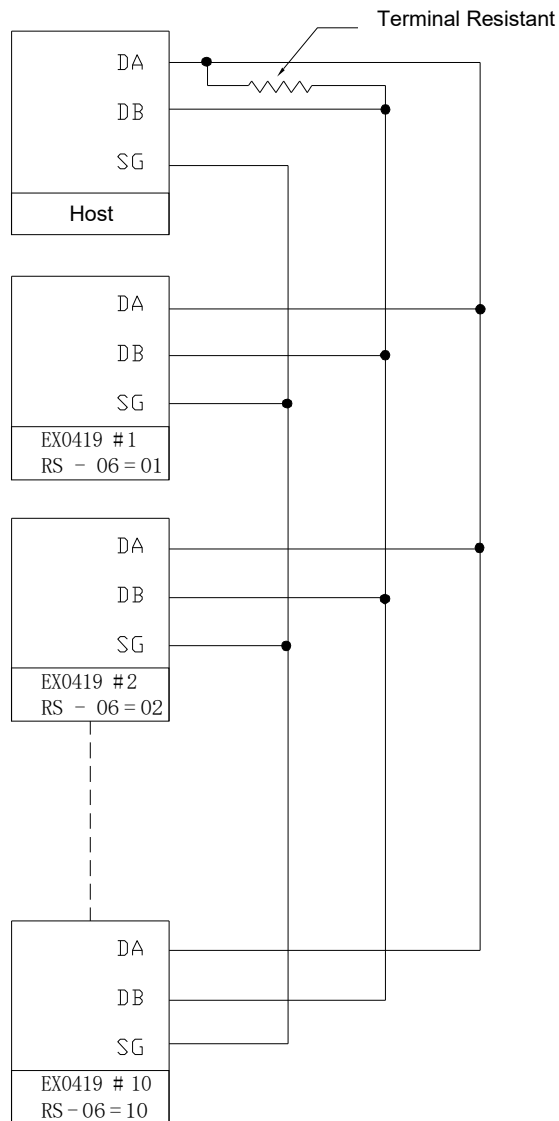





📄 Notice



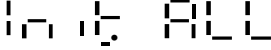

- ∅ If the terminal resistor is built-in the host interface, it's not necessary to connect with another one outside.
- ∅ If the host computer is no signal ground (SG), it's not necessary to connect with it.

Chapter 9 Maintenance



9-1 Default Recovery for All Parameters

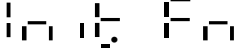

- (1) Adjust the calibration switch to “ON”, when re-zeroing after turning on, press   and hold simultaneously.
- (2) The screen will display 
- (3) If decided, press  and hold until displaying , and then adjust the calibration switch to “OFF”.

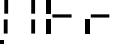

9-2 Default Recovery for General Function Parameters

- (1) When re-zeroing after turning on, press   and hold simultaneously.
- (2) The screen will display 
- (3) If decided, press  and hold until re-turning on.

9-3 Self-diagnosis Mode

- (1) When re-zeroing after turning on, press  and hold.
- (2) The screen will display , which means entered self-diagnosis mode.
- (3) Use  or  keys to select item intended to test.

Press  key to enter self-diagnosis, and press  key to exit.

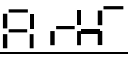
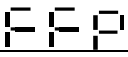
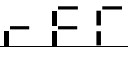
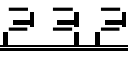
Item	Display	Testing Item
1		Program Version Number Displaying
2		7-segment Display Testing
3		Keypad and Calibration Switch Testing
4		AD Conversion Value Displaying
5		EEPROM Testing
6		RTC Date & Time Testing
7		OP-1 RS232 Serial Output Interface Testing

9-3-1 Program Version Number

7-segment display reveals program version number  XX.

9-3-2 7-segment Display Testing

7-segment display reveals  ~ and ".".

9-3-3 Keypad & Calibration Switch Testing

Adjust calibration switch to "ON", and press any key, the corresponding bit will be changed from .

9-3-4 AD Conversion Value

7-segment display reveals the internal value of the present weight.

9-3-5 EEPROM Testing

Displaying  represents in normal condition.

Displaying  represents in extraordinary condition.

9-3-6 RTC Time & Date Testing

Press  key to enter the testing mode, and the screen will display date XX.XX.XX.

Example: "05.11.03" represents 3rd of November, 2005.

Press  key again to display time XX.XX.XX.

Example: "09.45.50" represents 9 o'clock, 45 minute and 50 seconds.

9-3-7 RS-232 Serial Output Interface Testing (OP-01)

(1) Short the 2nd pin and 3rd pin of the SER. OUT. D-SUB 9 pin socket.

Displaying  represents in normal condition.

Displaying  represents in breakdown condition.

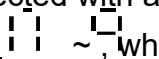
(2) If connected with a computer (protocol must be corresponding), the screen will display  ~, which means RS-232 output is in normal condition.

Appendix 7-SEGMENT DISPLAY CHARACTERS

Digit	7-Segment Letter	Alphabet	7-Segment Letter	Alphabet	7-Segment Letter
0		A		N	
1		B		O	
2		C		P	
3		D		Q	
4		E		R	
5		F		S	
6		G		T	
7		H		U	
8		I		V	
9		J		W	
		K		X	
		L		Y	
°C		M		Z	